

Joint Working Manual

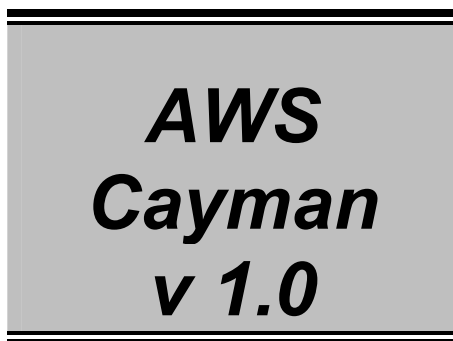

Table of Contents

1 CHAPTER 1 – TECHNICAL SPECIFICATION 4

1.1 INTRODUCTION..... 4

1.2 TECHNICAL CHARACTERISTICS FOR THE OPTICAL IN-SPAN JOINING SERVICE 4

 1.2.1 Principles..... 4

 1.2.2 Cable Routing & Resiliency 5

 1.2.3 Circuit Termination Unit Specification 5

 1.2.4 Process for accreditation of alternative CTU 6

 1.2.5 Optical Distribution Frame specification..... 6

1.3 2.048 MBIT/S NETWORK LINK CHARACTERISTICS 6

 1.3.1 Electrical characteristics..... 6

 1.3.2 Functional characteristics..... 6

 1.3.3 Synchronisation 7

 1.3.4 Safety and protection 7

 1.3.5 Electromagnetic Compatibility..... 7

1.4 NETWORK LINK QUALITY OF SERVICE 7

 1.4.1 Definitions 7

 1.4.2 Quality of Service levels 8

1.5 SIGNALLING..... 8

 1.5.1 Signalling Principles 8

 1.5.2 Circuit related signalling 8

 1.5.3 Protocols 8

 1.5.4 Parameter fields 8

 1.5.5 Signalling procedure 8

 1.5.6 Non-circuit related signalling 9

1.6 TRAFFIC HANDLING OF SERVICES..... 9

 1.6.1 Routing 9

 1.6.2 Trunk Groups..... 9

 1.6.3 Signalling Links 9

 1.6.4 Quality of Service for Termination Services, Special Access Services, and Transit Services 10

 1.6.5 Call Availability..... 10

 1.6.6 Dial Set-up Delay 11

 1.6.7 Propagation Delay 11

 1.6.8 Calling Line Identity..... 11

1.7 REFERENCES..... 11

2 CHAPTER 2 - OPERATIONS AND MAINTENANCE 14

2.1 OPERATIONS AND MAINTENANCE: INTRODUCTION..... 14

2.2 ROLES AND RESPONSIBILITIES 14

 2.2.1 Introduction 14

 2.2.2 Meetings 15

 2.2.3 Service Implementation 16

 2.2.4 Performance Reports..... 16

 2.2.5 Interconnect Resolution Log..... 16

 2.2.6 Technical disputes 17

2.3 FORECASTING, ORDERING AND PROVISIONING..... 17

 2.3.1 Forecasting..... 17

 2.3.2 Ordering 17

 2.3.3 Provisioning 19

 2.3.4 Compensation for inaccurate forecasts 19

 2.3.5 Compensation for delay in installation or acceptance testing 20

2.3.6 *Invoicing and Payment* 20

2.3.7 *Dispute Resolution*..... 20

2.4 ACCEPTANCE TESTING 21

2.5 FAULT MANAGEMENT 21

 2.5.1 *Fault Classification* 22

 2.5.2 *Fault Contact Centres and Fault assignment*..... 23

 2.5.3 *Fault Restoration*..... 24

 2.5.4 *Re-classifications, suspensions and escalation* 24

2.6 PLANNED AND EMERGENCY MAINTENANCE 25

2.7 MISCELLANEOUS O&M PROVISIONS 26

 2.7.1 *Procedure for alteration of numbers* 26

2.8 APPENDICES..... 26

APPENDIX I. MONTHLY PERFORMANCE AND ISSUE RESOLUTION 27

Appendix II. Forecast..... 29

Appendix III. Order Plan 32

Separate attachment. Appendix IV. Fault management form 34

Appendix IV. Fault management form 35

3 CHAPTER 3 - BILLING..... 37

 3.1 BILLING: INTRODUCTION 37

 3.2 DATA COLLECTION AND INVOICE PROCESSING 37

 3.3 INVOICE DISPUTES 37

 3.4 UNDETECTED BILLING ERRORS 37

 3.5 LATE USAGE 38

 3.6 VALIDATION 38

 3.7 RETENTION OF BILLING DATA 38

4 CHAPTER 4 – TESTING 39

 4.1 INTERCONNECT TESTING - OBJECTIVES & SCOPE 39

 4.1.1 *Objectives* 39

 4.1.2 *Scope* 39

 4.2 INTERCONNECT TESTING FRAMEWORK 39

 4.3 TEST SPECIFICATION STRUCTURE 40

 4.4 TEST PHASES 41

 4.4.1 *Individual Location Test Process* 41

 4.4.2 *Network Interconnection Test*..... 42

 4.4.3 *First Live Traffic Process* 43

 4.4.4 *Operational Field Trial Process*..... 44

 4.5 TEST SHEETS & REPORT 45

 4.6 TEST SUITES 45

 4.7 FAULT HANDLING PROCEDURE TO BE USED IN TESTING PHASES 47

 4.8 FAULT CLASSIFICATION 49

 4.9 ADDITIONAL ROLES AND RESPONSIBILITIES FOR TESTING 50

 4.10 INTERCONNECT TESTING DOCUMENTATION 50

APPENDIX I. SUMMARY OF INTERCONNECT TESTS 52

APPENDIX II. FAULT REPORT TEMPLATE FOR TESTING 53

APPENDIX III. FAULT LIST..... 54

1 Chapter 1 – Technical Specification

1.1 Introduction

1.1.1.1 This chapter describes the technical specifications applicable to the Services as described in the Service Descriptions. The specifications in this chapter are applicable to both Parties.

1.2 Technical characteristics for the Optical In-Span Joining Service

1.2.1 Principles

1.2.1.1 The Optical In-Span Joining Service is based upon the principle of one Telco ISL to one C&W ISL.

1.2.1.2 As described in the Optical In-Span Joining Service Description, the service will comprise:

- One Optical Fibre cable runs (which may consist of two or more Optical Fibre strands) from the Telco ISL to the C&W ISL (referred to as the route).

1.2.1.3 As described in the Optical In-Span Joining Service Description, a Carrier System comprises a Service Taker CTU, the matching Service Supplier CTU for the route, and the point-to-point Optical Fibre cable.

1.2.1.4 Carrier Systems based on Synchronous Digital Hierarchy (SDH) 155.52 Mbit/s (STM-1) will be used. All SDH systems should conform to SDH Transport Systems standards: G.707. The basic sub-rate of all the systems is 2.048 Mbit/s. Figure 1 represents a functional overview of the service.

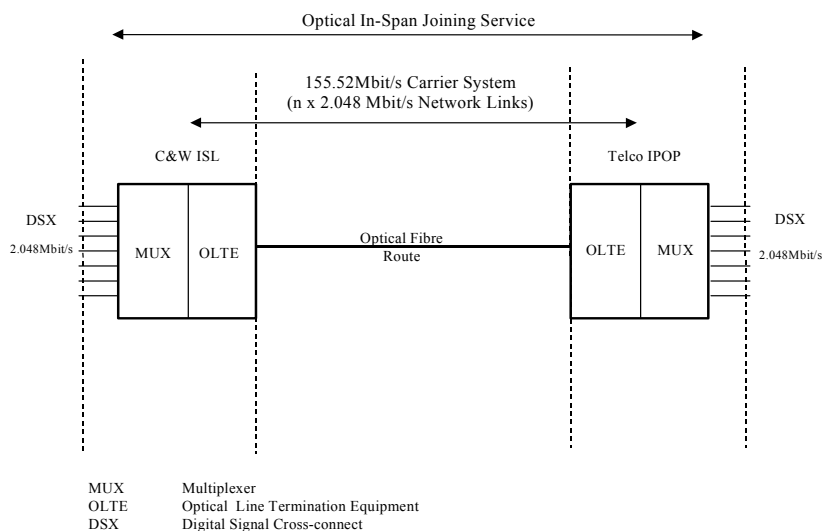

Figure 1: The Carrier System.

1.2.1.5 Single mode optical fibre cable is specified utilising 1330nm short haul interface conforming to G.957.

1.2.2 Cable Routing & Resiliency

1.2.2.1 No physical route diversity is provided.

1.2.2.2 Carrier System equipment resiliency may be provided upon request whereby a working fibre pair and a protecting fibre pair are provided on the same fibre route. Protection switching is facilitated by the CTU of each party in accordance with Sub-Network Connection Protection (SNC-P) standards specified in G.841 section 6.6.

1.2.2.3 Cables that enter and traverse cable vaults will be protected by concrete (outside building) and mechanical armour (within building).

1.2.2.4 The physical interface between the Telco System and the C&W System will be the STM-1 optical fibre interface. For the avoidance of doubt, the physical interface is not the same as the Point of Connection.

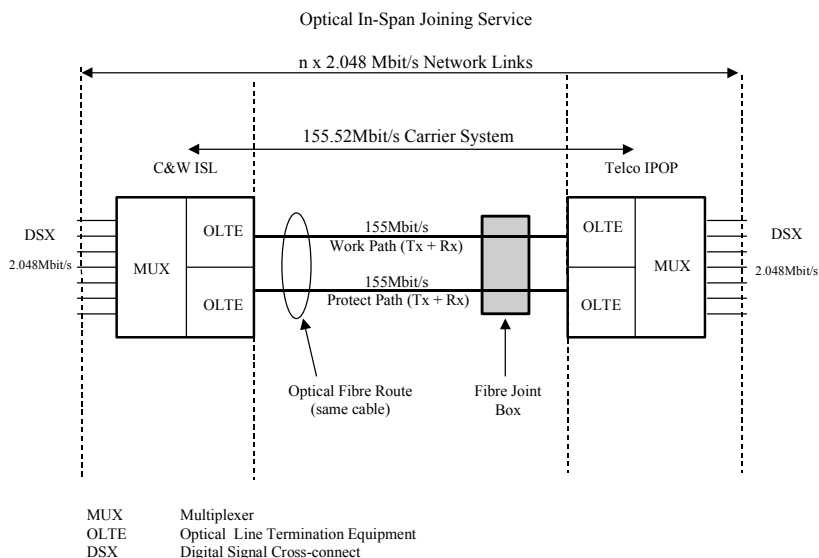

Figure 2: Carrier System resiliency

1.2.3 Circuit Termination Unit Specification

1.2.3.1 C&W approved suppliers, following testing:

Manufacturer	Product
Nortel Networks Corporation	TN-1C, TN-1X

Note: TN-1C is capable of supporting 32xE1s and the TN-1X is capable of supporting 63xE1s. Both systems utilize 155.52 Mbit/s Carrier Systems aggregate.

1.2.4 Process for accreditation of alternative CTU

- 1.2.4.1 All CTU equipment must conform to SDH standards and any additional standards specified in this technical chapter.
- 1.2.4.2 In advance of ordering, the alternative CTU manufacturer equipment specification shall be sent to the C&W Liaison Manager for technical evaluation. Further to this evaluation, some specific inter-operability testing may need to be planned and conducted. For the avoidance of doubt, interoperability testing will not be required where alternative CTU equipment is designed with identical interface specifications as equipment defined in Paragraph 1.2.3.1.

1.2.5 Optical Distribution Frame specification

- 1.2.5.1 The rack-mounted Optical Distribution Frame used as the demarcation between the networks must be capable of accommodating multiple (four or more) ST-type fibre termination ports. The Optical Distribution Frame must be mounted in an equipment rack.
- 1.2.5.2 The suggested supplier for the Optical Distribution Frame is Corning Cable Systems, specifically, any one of the FDC-CMH series of products.

1.3 2.048 Mbit/s Network Link Characteristics

1.3.1 Electrical characteristics

- 1.3.1.1 The output jitter shall not exceed 0.75 UI under worst case operating conditions when measured in the frequency range 20 Hz to 100 kHz, as defined in ITU-T G.921 table 3.
- 1.3.1.2 The tolerance of both the C&W and the Telco input ports to jitter should be as defined in ITU-T Recommendation G.823.
- 1.3.1.3 A jitter measuring set conforming to the requirements of ITU-T Recommendation O.171 (Timing Jitter Measuring Equipment for Digital Systems) shall be used to measure jitter. C&W and the Telco shall co-operate in the application of testing methods as described in ITU-T Recommendation G.823.
- 1.3.1.4 The wander specification is set out in ITU-T recommendation G.823. The maximum values of wander at input ports must conform to section 3.1.1 of ITU-T Recommendation G.823.

1.3.2 Functional characteristics

- 1.3.2.1 Each 2.048 Mbit/s Network Link shall be transparent and independent of any traffic stream passed across it.
- 1.3.2.2 The functional characteristics of the interface for the 2.048 Mbit/s Network Interconnection Link must conform to ITU-T recommendations G.704 and G.706 and the additional requirements specified below.
- 1.3.2.3 2048 kbit/s interfaces shall conform to ITU-T G.803 and G.821 for generation of AIS and RAI alarms, and with G.823 for slipping conditions.
- 1.3.2.4 At the digital interface the analogue information shall be encoded using the 8bit, A-law characteristic in accordance with ITU-T Recommendation G.711 such that a 64kbit/s time slot at the Switch Connection can be decoded using an 8 bits, A-law decoder. The bit pattern of a free channel shall be in conformity with ITU-T recommendation Q.522, section 2.1.2.

1.3.3 Synchronisation

- 1.3.3.1 The Telco shall synchronise on the C&W System.
- 1.3.3.2 The Telco shall synchronise on the C&W System via nominated Network Links when using an STM-1 Carrier System.
- 1.3.3.3 C&W will provide the 2.048 Mbit/s interface for synchronisation for the Telco Switch. Inputs will have a minimum accuracy of Stratum 3 in accordance with G.813.
- 1.3.3.4 The nominated synchronisation channels will be agreed as part of the order process.
- 1.3.3.5 The maximum wander shall conform to ITU-T G.811 and G.812. The synchronisation provided by C&W meets the requirements of ITU-T G.703 and is traceable to Stratum 1 source (minimum accuracy of $\pm 1 \times 10^{-11}$).

1.3.4 Safety and protection

- 1.3.4.1 All equipment will comply with UL 1950 and/or national safety standards whichever is the most stringent.
- 1.3.4.2 For high voltages, equipment will comply with ITU-T K.11.
- 1.3.4.3 If radio equipment is used, it will comply with the International standard ITU-T K.37 to protect employees from electromagnetic radiation with a power in excess of 1 milliwatt per centimetre.
- 1.3.4.4 The screen of the cable at an output port must be connected to the metal cabinet, which holds the equipment. The screen of the cable at an input port must be earthed.

1.3.5 Electromagnetic Compatibility

- 1.3.5.1 All link equipment must comply with ITU-T K.43 for network equipment Electromagnetic Compatibility (EMC) requirements and must comply with any national regulations relating to electromagnetic and electrostatic compatibility.
- 1.3.5.2 All link equipment must comply with ITU-T K.42 for immunity to radiated electromagnetic energy.
- 1.3.5.3 All link equipment must comply with ITU-T K.32 for electrostatic discharge
- 1.3.5.4 All link equipment must comply with EN 55022 class B or FCC Part 15 for radiated and conducted emissions.
- 1.3.5.5 All link equipment must comply with any national regulations relating to electromagnetic and electrostatic compatibility.
- 1.3.5.6 The link equipment must be immune to radiated electromagnetic field of up to 3V/m.

1.4 Network Link Quality of Service

1.4.1 Definitions

- 1.4.1.1 Network Link Availability, Errored Seconds and Severely Errored Seconds are the parameters used to measure the service quality of the Network Link. These quality of service parameters are applicable to all Network Links that are delivered by C&W as well as to all Network Links that are delivered by the Telco. Measurements of these service quality parameters will be specified in units relating to calendar months.

1.4.1.2 The definition of Network Link Availability (%) for a Party is

$$100 * \frac{(\text{total time} - \text{time allocated to Planned Maintenance} - \text{time the link is not available for traffic due to faults})}{(\text{total time} - \text{time allocated for Planned Maintenance})}$$

during the specified calendar month.

1.4.1.3 The definition of Errored Second is a one second interval with one or more bit errors.

1.4.1.4 The definition of Severely Errored Second is a one-second period which has a bit error ratio greater than or equal to 10^{-3} .

1.4.2 Quality of Service levels

1.4.2.1 The following Quality of Service level is applicable to the Network Links.

1.	Network Link Availability	> 99.6%
2.	Percentage of Severely Errored Seconds	≤ 0.055%
3.	Error Free Seconds	> 99.0%

1.5 Signalling

1.5.1 Signalling Principles

1.5.1.1 Signalling applied shall be Signalling System No. 7 (C7) which conforms to ETSI standards. Operator dependent implementations of the signalling protocol at the network interconnection interface will not be supported.

1.5.1.2 In principle C&W will transfer signalling messages transparently through its network. However, C&W cannot guarantee proper end-to-end inter-working of services originating or terminating outside the C&W network.

1.5.2 Circuit related signalling

1.5.2.1 3.1Khz audio and speech bearer services are supported.

1.5.3 Protocols

1.5.3.1 The MTP (ETS 300 008) and ETSI ISUP V1/V2 (ETS 300 121) protocols are supported.

1.5.3.2 The signalling mode is fully associated.

1.5.4 Parameter fields

1.5.4.1 Network indicator 11 (binary notation) and National Transit Domain point-codes shall be used. The CLI represents the national significant number or international number depending on the source of the call. The nature of address indicator shall be set accordingly. The address presentation restriction indicator shall not contain the values "spare" or "address not available".

1.5.5 Signalling procedure

1.5.5.1 All calls to national significant numbers shall use en-bloc-signalling mode of operation.

1.5.5.2 In case of overlap signalling mode of operation the Address Complete Message shall be sent as soon as all digits necessary to complete the call are received.

1.5.5.3 Stop digits for indicating that the full number is transmitted shall be used where necessary.

1.5.5.4 The required called party number format, nature of address, number length (range) and signalling mode of operation as passed between the networks is specified in the Parameter Schedule.

1.5.6 Non-circuit related signalling

1.5.6.1 The MTP (ETS 300 008) and ETSI SCCP (ETS 300 009) protocols are supported.

1.5.6.2 The signalling mode is fully associated.

1.5.6.3 It is preferred that the signalling transfer function is also applied by the Telco in order to maximize efficiency regarding the number of signalling links.

1.6 Traffic Handling of Services

1.6.1 Routing

1.6.1.1 The location of the ISL at which Services is provided pursuant to this Agreement are specified in the Service Schedule.

1.6.1.2 Each party will undertake the routing/translation for all codes that require re-routing/re-translation across its network.

1.6.2 Trunk Groups

1.6.2.1 Separate Trunk Groups per Service or for a group of services will be agreed.

1.6.2.2 All trunk groups will be uni-directional.

1.6.2.3 The separate Trunk Groups between the Telco ISL and the corresponding C&W ISL are specified in the Parameter Schedule.

1.6.3 Signalling Links

1.6.3.1 A minimum of two Signalling Links will be provided between the C&W System and the Telco System.

1.6.3.2 C&W and the Telco will maintain equal loading of the Signalling Links.

1.6.3.3 The Signalling Links will be designed for a normal load of 0.2E and a maximum load of 0.4E following the guidelines of ETS 300 008.

1.6.3.4 The dimensioning of Signalling Links will be determined by the number of Call attempts using Erlangs formula.

1.6.3.5 This formula is applicable when Signalling Links are used for circuit related signalling and the number of links will be subsequently monitored, and adjusted, should this be necessary, according to specific traffic type.

1.6.3.6 The Signalling Links shall be used exclusively for the exchange of signalling messages.

1.6.4 Quality of Service for Termination Services, Special Access Services, and Transit Services.

1.6.4.1 The Quality of Call related Termination Services, Special Access Services, and Transit Services are represented by the parameters Call Availability, Dial Set-up Delay and Propagation Delay.

1.6.4.2 Depending on the Service offered the Service Supplier has a role as:

- **originating party.** In this role the Service Supplier handles calls from the Subscriber Connection of the calling party in the originating network to the Point of Connection .
- **transit party.** In this role the Service Supplier handles calls from the Point of Connection or Point of Handover as the case may be via the national transit network to the Point of Handover or Point of Connection as the case may be.
- **terminating party.** In this role the Service Supplier handles calls from the Point of Connection to the called Subscriber Connection of the called party in the terminating network.

1.6.4.3 For each Quality of Service parameter a value is defined.

1.6.5 Call Availability

1.6.5.1 The definition of Call Availability (%) is

$$100 * \frac{\text{(total call attempts – total call releases with causes marked as network fault)}}{\text{(total call attempts)}}$$

during a specified period of time.

Release causes marked as network faults are the following causes specified in ITU-T rec. Q.850:

- * no circuit/channel available
- * network out of order
- * temporary failure
- * switching equipment congestion
- * access information discarded
- * requested circuit/channel not available
- * resource unavailable, unspecified
- * bearer capability not presently available
- * protocol error, unspecified
- * interworking, unspecified.

1.6.5.2 The Call Availability is > 99%. The apportionment for the Call Availability budget for Service Supplier and Service Taker is as follows:

Originating party	Transit party	Terminating party
≥99.6 %	≥99.8 %	≥99.6 %

1.6.6 Dial Set-up Delay

1.6.6.1 Dial Set-up Delay is defined as the interval from the moment that the last digit of the called party number is keyed by the calling party to the time a relevant tone (ring tone/busy/information tone/message) is received by the calling party.

1.6.6.2 Dial Set-up Delay Quality of Service parameter shall be no more than 2350 ms for a national Call.

1.6.6.3 The apportionment for the Dial Set-up Delay value for Service Supplier and Service Taker is as follows:

Originating party	Transit party	Terminating party	Database access if applicable
575 ms	700 ms	575 ms	500 ms

1.6.7 Propagation Delay

1.6.7.1 Propagation Delay is defined as the round trip delay between the received signal and the transmitted signal.

1.6.7.2 The Propagation Delay Quality of Service parameter shall be no more than 22ms. Both Parties will take appropriate actions (e.g. echo cancellation) if this Propagation Delay is exceeded.

1.6.7.3 The apportionment for the Propagation Delay budget for Service Supplier and Service Taker is as follows:

Originating PBX network if applicable	Originating party	Transit party	Terminating party	Terminating PBX network
5 ms	4.5 ms	3 ms	4.5 ms	5 ms

1.6.8 Calling Line Identity

1.6.8.1 All interconnect trunks will utilise Q.731 signalling through which CLI shall be passed transparently.

1.6.8.2 All numbers with CLI are transparent between networks. Calling Number Delivery Blocking (CNDB) shall be applied to all private numbers within the C&W System and the Telco System. C&W and the Telco should ensure that CLI associated with numbers with the CNDB feature is blocked from Subscriber Connections.

1.7 References

ITU-T Recommendation

- G.703 “Physical/electrical characteristics of hierarchical digital interfaces”
- G.711 “Pulse code modulation (PCM) of voice frequencies”

G.821	“Error performance of an international digital connection forming part of an integrated services digital network”
G.824	“The control of Jitter and wander within digital networks which are based on the 1.544 Mbit/s hierarchy”.
O.171	“Timing Jitter measuring equipment for digital systems”
K.11	“Principles of protection against over voltage and over current”
K.42	“Preparation of emission and immunity requirements for telecommunications equipment”
K.43	“Immunity requirements for telecommunications equipment”
K.37	“Public Telecommunications network equipment EMC requirements Part I: Product family overview, compliance criteria and test levels”
UL 1950	“Standard for Safety for Information Technology Equipment, 3rd Edition”
G.111	“Loudness ratings (LRs) in an international connection”
G.113	“Transmission impairments”
G.703	“Physical/electrical characteristics of hierarchical digital interfaces”
G.704	“Synchronous frame structures used at primary and secondary hierarchical levels”
G.706	“Frame alignment and cyclic redundancy check (CRC) procedures relating to basic frame structures defined in Recommendation G.704”
G.711	“Pulse code modulation (PCM) of voice frequencies”
G.811	“Timing characteristics of Primary Reference Clocks”
G.812	“Timing requirements of slave clocks suitable for use as node clocks”
G.813	“Timing characteristics of SDH slave clocks”
G.821	“Error performance of an international digital connection forming part of an integrated services digital network”
G.823	“The control of Jitter and wander within digital networks which are based on the 2048 kbit/s hierarchy”.
G.826	“Error performance parameters and objectives for international, constant bit rate digital paths at or above the primary rate”
G.841	“Types and characteristics of SDH network protection architectures”
G.921	“Digital sections based on the 2048 kbit/s hierarchy”
G.957	“Optical interfaces for equipment and systems relating to SDH”
O.151	“Error performance measuring equipment operating at the primary rate and above”
O.171	“Timing Jitter measuring equipment for digital systems”
Q.522	“Digital exchange connections, signalling and ancillary functions”
ETS 300 008	“Integrated Service Digital Network (ISDN); ITU-T Signalling System No.7; Message Transfer Part (MTP) to support international

(1991)	interconnection”
ETS 300 009 (1991)	ITU-T Signalling System No.7; Signalling Connection Control Part (SCCP) to support international interconnection”
ETS 300 121	“Integrated Service Digital Network (ISDN); ITU-T Signalling System No.7; Application of the ISDN User Part (ISUP) of CCITT Signalling System No.7 for international ISDN interconnections.”
ETS 300 356-1 (1995)	“Integrated Services Digital Network (ISDN); Signalling System No.7. ; ISDN User Part (ISUP) version 2 for the international interface; Part 1: Basic services [ITU-T Recommendations Q.761 to Q.764 (1993), modified].”
ETS 300 356-3 (1995)	“Integrated Services Digital Network (ISDN); Signalling System No.7; ISDN User Part (ISUP) version 2 for the international interface; Part 3: Calling Line Identification Presentation (CLIP) supplementary service [ITU-T Recommendation Q.731, clause 3 (1993), modified].”
ETS 300 356-4 (1995)	“Integrated Services Digital Network (ISDN); Signalling System No.7; ISDN User Part (ISUP) version 2 for the international interface; Part 4: Calling Line Identification Restriction (CLIR) supplementary service [ITU-T Recommendation Q.731, clause 4 (1993), modified].”

2 Chapter 2 - Operations and Maintenance

2.1 Operations and Maintenance: Introduction

2.1.1.1 This chapter specifies the operations and maintenance principles that C&W and the Telco will be required to conform to following signing of the Agreement. It describes the processes for Services provided by each Party and the exchange of information between Parties.

2.1.1.2 The following processes are covered in this chapter.

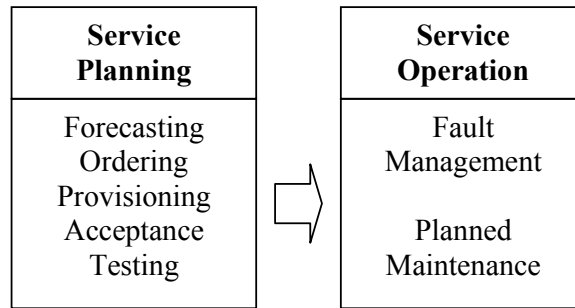

Figure 1 Operational Processes

2.2 Roles and Responsibilities

2.2.1 Introduction

2.2.1.1 This section describes the functions from each Party’s organisation that are required to assure the effective management and execution of processes. The roles, which may be combined, are:

I. Liaison Manager

The Liaison Manager has overall responsibility for preliminary discussions regarding service planning, implementation and operational processes. Information should be exchanged between Liaison Managers, unless stated otherwise in this manual.

II. Operations Manager

The Operations Manager has responsibility for managing the day-to-day Quality of Service including operational processes.

III. Project Manager

The Project Manager has responsibility for the service planning, commissioning, testing and implementation for new and additional Services. The Project Manager will track the activities relating to

IV. Planning Manager

The Planning Manager has responsibility for forecasting and planning services and dimensioning of facilities for new and additional Services. Communications will generally be through the Project

forecasting, ordering, provisioning and testing and will keep the Liaison Manager abreast of related issues.

Manager to allow project co-ordination and monitoring.

V. Fault Control Manager
The Fault Control Manager has responsibility for managing a 24-hour, all days a year Fault Contact Centre (FCC) for its respective network. The Fault Contact Centre will own, identify and resolve relevant faults.

VI. Service Quality Manager
The Service Quality Manager has responsibility for monitoring service performance.

2.2.1.2 The relationship between the roles is illustrated in the figure 2 below:

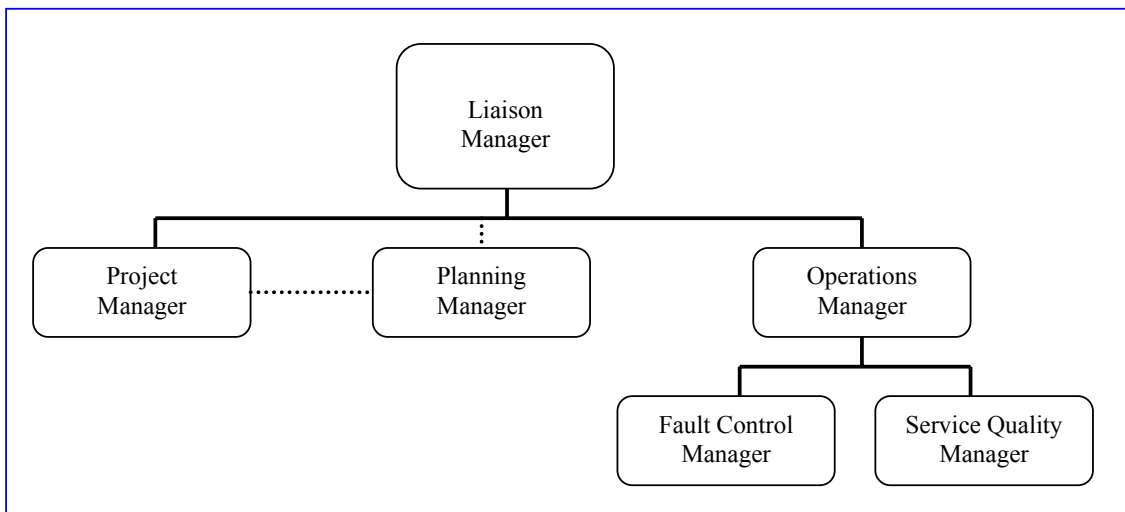

Figure 2 Relationships between roles

2.2.2 Meetings

2.2.2.1 Periodic meetings involving representatives from both Parties will be held, at least quarterly, and may be held face to face or by teleconference. Meetings will consider issues relating to implementation and operation of Services provided pursuant to this Agreement.

2.2.2.2 Service Implementation Meetings will include Forecasting Meetings, Order Planning Meetings, Provisioning Meetings and Testing Meetings.

2.2.2.3 Forecasting Meetings will consider, inter alia, the service forecasts of both Parties and will seek to validate any assumptions used in making the forecasts.

2.2.2.4 Order Planning Meetings will consider, inter alia, the final forecast and will lead to the production of an Order Plan.

2.2.2.5 Provisioning Meetings will, inter alia, review progress against plans and lead to agreement on any changes required.

2.2.2.6 Testing Meetings will, inter alia, review the process, the test stages, the test suites, the test plan and service acceptance. Any additional inter-operability testing that is required as a result of differences in standards or the introduction of new technology will also be included.

2.2.2.7 Additional technical meetings may be held prior to the provisioning phase for the early exchange of information regarding technical standards, the numbering scheme of each network, switch identification, routing etc.

2.2.2.8 Operational Meetings will inter alia

- review process performance by comparing actual and agreed quality of service levels
- review operational problems that affect the quality of service levels
- review of Interconnect Resolution Log
- agree on quality initiatives
- discuss Performance Reports

2.2.3 Service Implementation

2.2.3.1 The service implementation process is shown in Figure 3 below.

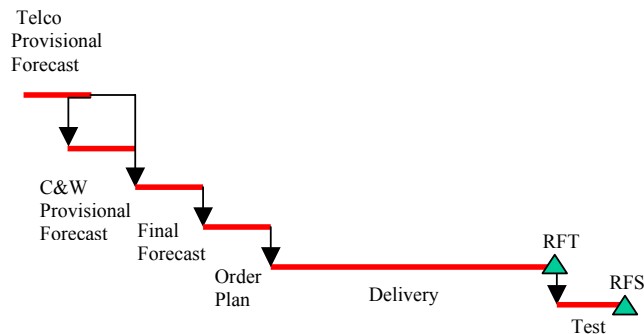

Figure 3. Service planning

2.2.4 Performance Reports

2.2.4.1 Written Performance Reports will be exchanged monthly and will include:

- Services that have been forecasted and ordered, in the role of Service Taker, and services that have been delivered in the role of Service Supplier; and
- Service performance data.

2.2.4.2 The minimum set of items to be included in the Performance Report is listed in Appendix I.

2.2.5 Interconnect Resolution Log

2.2.5.1 The resolution process is a mechanism for recording, tracking and ultimately resolving interconnect issues that have not been resolved within established time periods and through normal processes.

2.2.5.2 An Interconnect Resolution Log will be maintained to keep track of interconnect issues and their status. This log (which will include the items set out in Appendix 1) will be maintained by the Parties and shall be reviewed at the Operational Meetings.

2.2.6 Technical disputes

2.2.6.1 In the event of any dispute arising in respect of any technical matter in connection with this Agreement (other than technical matters in relation to fault resolution prior to the exhaustion of the fault escalation procedure), such dispute shall in the first instance be referred to the Parties' respective Liaison Managers for resolution. In the event that the Liaison Managers shall fail to resolve such dispute within thirty (30) days of the matter being referred to them, either Party may refer the dispute for determination in accordance with the process specified in Clause 34. The Parties shall co-operate in such process and will make all relevant information and technical data available to the expert.

2.3 FORECASTING, ORDERING AND PROVISIONING

2.3.1 Forecasting

2.3.1.1 The forecasting process requires both Parties to plan and exchange Forecasts for each applicable Service provided pursuant to this Agreement, and to ensure that changes to the Forecasts are communicated in a timely fashion.

2.3.1.2 The exchange of Forecast information is required to enable each Party to plan and manage its System and human resources. The process is ongoing over a rolling 24-month period with quarterly updates.

2.3.1.3 Each Party has the opportunity to comment on the validity of provisional Forecast information in the forecasting meetings, and to review any assumptions used. Each Party is encouraged to provide appropriate supplementary information to aid the development of Forecasts.

2.3.1.4 All information exchanged will be treated as confidential, and will not be used for any purpose other than as set out in this Joint Working Manual.

2.3.1.5 Each Party shall provide a provisional Forecast for all Services that they require (in the role of Service Taker) from the other Party (in the role of Service Supplier) for the ensuing two-year period. This provisional Forecast will consist of the locations and number of Network Links within the Joining Service, together with traffic forecasts for all other Services provided pursuant to this Agreement. Traffic forecasts will include the locations of the applicable Point of Connection and the location of the associated Point of Handover. In addition, forecasts for Special Access Services will include an estimated number of Calls. The Parties will exchange forecasts on agreed dates each quarter, using the forms in Appendix II.

2.3.1.6 The two Parties will meet shortly thereafter to agree on the Forecast data in relation to the following Quarter; such agreed Forecast data will be called the "Final Forecast" and will include the combined provisional forecasts of both parties (with any agreed amendments).

2.3.2 Ordering

2.3.2.1 The Parties will agree an Order Plan for each Quarter at the preceding quarterly ordering meeting and following sign-off by both Parties the Order Plan shall be treated as submitted and shall constitute a binding Order from each Party for capacity. The relevant

Final Forecast will be an integral component of the Order. The format of the Order Plan is given at Appendix III.

- 2.3.2.2 The Order Plan will include a Ready for Test Date and Ready for Service Date for the capacity. These dates will depend on whether additional Network Links are required, whether an additional Carrier System is required or whether a new Joining Service is required and on the location of the applicable Telco ISL and associated C&W ISL and will be agreed between the Parties on a case by case basis.
- 2.3.2.3 The decision as to whether a new Joining Service or additional Carrier System is required will be based on the Final Forecast and, if necessary, appropriate variations made to the Service Schedule and other relevant parts of this Agreement. For the avoidance of doubt, since the Order Plan will be based on the Final Forecast, it will represent an order for capacity in both directions.
- 2.3.2.4 For the avoidance of doubt, the Order Plan will not include a specific use requirement for any Termination Service, Special Access Service, or Transit Service but the Parties recognise that the Final Forecast for those Services will be used to agree an Order Plan for capacity and will be used by the Service Supplier to anticipate likely demand for those Services.
- 2.3.2.5 The Ready for Test Date and Ready for Service Date may be subject to delays caused by third parties, events beyond the Service Supplier's control and delays caused by the Service Taker not complying with its obligations, providing insufficient or inaccurate information or not co-operating with the Service Supplier. In the event of any delay attributable to such third parties, events and delays caused by the Service Taker, the Ready for Test Date and/or Ready for Service Date shall be deemed extended by the number of days of delay and the Service Supplier shall not be liable therefore. References to the Service Supplier and Service Taker are to the Service Supplier and Service Taker of the relevant Joining Service.
- 2.3.2.6 In the event that a Service Taker shall notify the Service Supplier that it wishes to cancel any capacity specified in an Order Plan (whether prior to or following provisioning), the Service Supplier shall be entitled to invoice the Service Taker for the Early Termination Charge in respect of such capacity and the Service Taker shall make payment of such amount within thirty (30) days of the date of such invoice. For the avoidance of doubt, termination of this Agreement under any of Clauses 23.2, 23.3, and 25.5 shall be deemed to effect a cancellation of the capacity specified in all Order Plans then being provided. For the purposes of this paragraph, a Service Supplier shall be the Service Supplier of Joining Services, and the terms Service Supplier and Service Taker shall be construed accordingly.
- 2.3.2.7 The Parties agree that the Early Termination Charges represent a reasonable pre-estimate of a Service Supplier's loss on any actual or deemed cancellation of an Order in the circumstances specified in Paragraph 2.3.2.6 and that such amounts shall not be regarded as or deemed to be onerous or a penalty.

2.3.3 Provisioning

2.3.3.1 After the submission of the Order Plan, both Parties shall carry out the necessary preparations required for installation of the Services.

2.3.3.2 The Service Supplier and the Service Taker will use their reasonable endeavours to perform all activities to ensure that the Carrier Systems and E1 Network Links are in place to meet the agreed Ready for Test Date and Ready for Service Date.

2.3.3.3 If a Party envisages a delay to the Ready for Test Date or Ready for Service Date, it will inform the other Party in writing within 24 hours clearly indicating the reasons for the delay and any proposed revised Ready for Test Date or Ready for Service Date and the Parties shall seek to agree a revised date.

2.3.3.4 Both Parties shall seek to minimise delay and the effects of delay.

2.3.4 Compensation for inaccurate forecasts

2.3.4.1 Compensation shall be payable by the Service Taker to the Service Supplier in the following cases:

- (a) where in relation to any Quarter, the Relevant Forecast exceeds the Relevant Traffic by at least the Forecast Threshold; and/or
- (b) where in relation to any Quarter, the Operator's Forecast exceeds the Operator's Traffic by at least the Forecast Threshold.

2.3.4.2 For these purposes:

- (a) the Relevant Forecast for any Quarter shall be the aggregate Final Forecast of the Service Taker's aggregate traffic utilizing any of the Services during such Quarter between each Telco ISL and the corresponding C&W ISL;
- (b) the Relevant Traffic for any Quarter shall be the Service Taker's aggregate traffic utilizing any of the Services during that Quarter between each Telco ISL and the corresponding C&W ISL;
- (c) the Operator's Forecast for any Quarter shall be the aggregate Final Forecast of the Service Taker's aggregate traffic utilizing any of the Operator's during such Quarter between each Telco ISL and the corresponding C&W ISL;
- (d) the Operator's Traffic for any Quarter shall be the Service Taker's aggregate traffic utilizing any of the Operator's during that Quarter between each Telco ISL and the corresponding C&W ISL; and
- (e) the Forecast Threshold shall be 20% of the Relevant Forecast or such other percentage as may be agreed between the parties.

2.3.4.3 Subject to Paragraph 2.3.4.5, in the event that (i) the Relevant Forecast for any Quarter shall exceed the Relevant Traffic by at least the Forecast Threshold and/or (ii) the Operator's Forecast for any Quarter shall exceed the Operator's Traffic by at least the Forecast Threshold, the Service Supplier shall be entitled to receive payment from the Service Taker, by way of compensation, of the Service Supplier's non-recoverable costs flowing from such inaccurate forecast or inaccurate forecasts and from any resultant inaccuracies in the Service Supplier's own forecast or forecasts.

2.3.4.4 In the event that the Relevant Traffic for any Quarter shall exceed the Relevant Forecast, the Service Supplier shall use its reasonable endeavours subject to availability

to provide the Services in respect of traffic exceeding such Relevant Forecast, but shall have no liability for any failure to do so or for any reduced Quality of Service.

2.3.4.5 Neither Party shall be liable to make payment of compensation:

- (a) in respect of a Relevant Forecast relating to any Quarter which occurs within the first twelve months following signature of an Agreement; and
- (b) to the extent that the difference between the Relevant Forecast and Relevant Traffic, or between the Operator's Forecast and Operator's Traffic, as appropriate, in respect of any Quarter is directly attributable to any failure by the other Party, (in the event that such Party is Service Supplier of a Joining Service to be delivered during the Quarter in question) to deliver such Joining Service in accordance with Paragraph 2.3.5.1.

2.3.4.6 For the purposes of Paragraphs 2.3.4.1 - 2.3.4.5, the Service Supplier, in each case, shall be responsible for the measurement of the Relevant Traffic and Operator's Traffic for each Quarter. In the absence of manifest error, any statement produced by the Services Supplier of the Relevant Traffic and Operator's Traffic shall be considered definitive.

2.3.4.7 For the avoidance of doubt, the obligation to compensate set out in Paragraphs 2.3.4.1 - 2.3.4.5 is designed to recover costs flowing from inaccurate ordering of capacity. Liability for compensation is assessed by reference to the forecasts for services carried over such capacity since that is the basis upon which the Order Plan for the capacity will be prepared.

2.3.5 Compensation for delay in installation or acceptance testing

2.3.5.1 Subject to Paragraph 2.3.2.5, in the event that, in relation to any capacity, the Ready for Test Date or Ready for Service Date is not met through the act or omission (including negligence) of the Service Supplier, the Service Taker shall be entitled to claim compensation for any of its fully-documented costs arising out of or in connection with such delay for which the Service Supplier would be liable under this Agreement.

2.3.5.2 Any dispute as to an amount payable under Paragraph 2.3.5.1 of this Joint Working Manual shall be resolved in accordance with the process set out in Clause 34.

2.3.6 Invoicing and Payment

2.3.6.1 In the event that either Party shall be entitled to receive payment under Paragraphs 2.3.4 or 2.3.5 it shall be entitled to invoice the other Party for the relevant amount immediately upon such entitlement arising. Any invoice shall include a breakdown of the cost elements included in the relevant amount. Any such invoice shall be payable within thirty (30) days of the date of deemed delivery.

2.3.7 Dispute Resolution

2.3.7.1 If either Party liable to pay compensation ("the Penalty Payer") disagrees with the estimate of loss, either Party may refer the matter for resolution in accordance with the procedures set out in Clause 34.

2.4 ACCEPTANCE TESTING

- 2.4.1.1 The acceptance testing process requires both Parties to ensure that all required E1 Network Links within the Carrier System(s) in the Joining Service and any applicable Services are operational by the agreed Ready for Service Date (or other agreed date) to the agreed operational specifications and at the lowest practicable cost.
- 2.4.1.2 Plans for acceptance testing will be included in the Order Plan and shall consist of the standard suite of tests in accordance with Chapter 4 of the Joint Working Manual.
- 2.4.1.3 Any subset of the standard suite of tests to be used will be agreed by both Parties on a case-by-case basis. The Service Supplier of the Joining Service will supply the other Party with all relevant test documentation. The Service Taker shall liaise with and provide full co-operation to the Service Supplier in the performance of such acceptance tests.
- 2.4.1.4 Within one month of submission of the Order Plan, the two Parties shall jointly develop a test plan in accordance with Chapter 4 of the Joint Working Manual. The test plan shall include all required tests to be performed at specified intervals throughout the implementation of the Order Plan and the contact names and telephone numbers of representatives of both Parties.
- 2.4.1.5 Both Parties shall sign the test plan at least one month before the expected start of acceptance testing. Any delay in signing the test plan may result in a consequential delay of all previously scheduled implementation dates.
- 2.4.1.6 Prior to the scheduled Ready for Test Date (or other agreed date), all Carrier Systems, E1 Network Links and signalling links to be used during acceptance testing must be in place and Individual Location Tests must have been successfully completed.
- 2.4.1.7 At least five (5) Business Days before the scheduled Ready for Test Date (or other agreed date), the Service Supplier of the Joining Service shall advise the Service Taker whether the provisioning has been completed and acceptance testing can commence.
- 2.4.1.8 All acceptance test results will be recorded in a test report in accordance with Chapter 4 of the Joint Working Manual and both Parties will retain copies for future reference.
- 2.4.1.9 If the acceptance testing is successful, each Party will sign the acceptance test reports within five (5) Business Days of completion.
- 2.4.1.10 If acceptance testing is unsuccessful within the initially agreed time frame, the Parties may agree on a partial acceptance testing, with the understanding that full compliance will be met by an agreed date.
- 2.4.1.11 If either Party cannot accept the Carrier System and/or Network Links and/or Service with partially successful acceptance testing, then the reasons for non-acceptance should be documented and the report signed indicating non-acceptance. The Parties will agree what action should be taken, including any timeframe for remedial work and re-testing. Any disputes will be resolved in accordance with Clause 34.

2.5 FAULT MANAGEMENT

The fault management process adopted by both Parties shall ensure the prompt restoration of agreed quality of service.

2.5.1 Fault Classification

2.5.1.1 Faults arising in segments of the network illustrated in figure 4 will be classified as follows:

- i. *Carrier System Fault*
A Fault resulting in the total loss of ability by either Party to transmit Calls between the two Systems due to transmission faults on the E1 Network Link or an entire Carrier System
- ii. *Network Fault*
A Fault located within the C&W System (C&W Network Fault) or within the Telco System (Telco Network Fault). Network Faults include faults within the signalling networks.

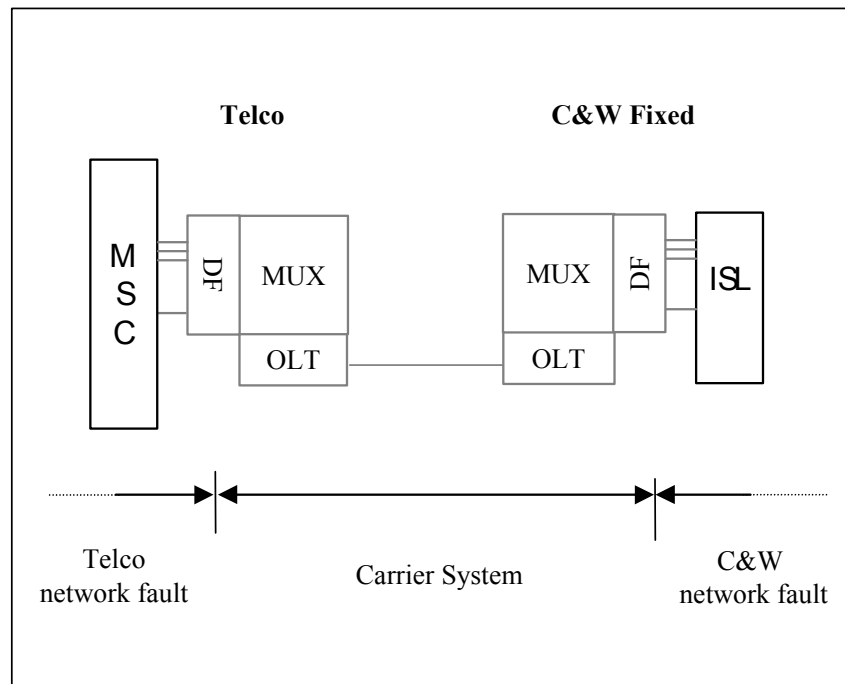

Figure 4. Fault Classification in Network Segments

2.5.1.2 Faults will be addressed depending on individual circumstances, with Service Affecting faults having the higher priority:

- i. *Service Affecting (SA)*
Faults that result in a noticeable deterioration in the Quality of Service:
 - a. Carrier System Faults for which the Fault Reporting Party can demonstrate a total loss of ability by either Party to transmit calls between Systems due to transmission faults within the Carrier System (Critical Link Failure);
 - b. Network Faults for which there is a Critical Link Failure or Major Link Failure or Route Failure and for which the Fault Reporting Party can demonstrate:

- severely restricted ability by either Party to convey Calls between the two Systems ; or
- Total loss of, or severely restricted access to one or more of the Numbering Ranges which reside on either Party's System ; or
- Total loss of, or severely restricted access to one or more of the number ranges which reside on a Third Party Telecom Provider's System , where the Calls are transited via either Party's System; or
- a loss of Service deemed as 'business critical' by either Party

ii *Non Service Affecting (NSA)*

A Fault which is not Service Affecting

2.5.1.3 Critical Link Failure, Major Link Failure, and Critical Route Failure, Major Route Failure and Minor Route Failure are defined as follows:

Fault type	Classification
Critical Link Failure	<i>100% of total signalling capacity is unavailable</i>
Major Link Failure	<i>50% of total signalling capacity is unavailable</i>
Critical Route Failure	<i>50% or more of total capacity of the route is unavailable to carry traffic.</i>
Major Route Failure	<i>25% to < 50% of total capacity of the route is unavailable to carry traffic</i>
Minor Route Failure	<i>1% to < 25% of total capacity of the route is unavailable to carry traffic</i>

2.5.2 Fault Contact Centres and Fault assignment

- 2.5.2.1 Each Party is required to provide a Fault Contact Centre (FCC) for Fault reporting and Fault management. Each FCC should operate twenty-four (24) hours per day, seven (7) days per week and all days per year. FCCs for each Party should have specified contact numbers.
- 2.5.2.2 Either Party can report a Fault. Each FCC will maintain a unique set of FCC Log Numbers. When one Party's FCC reports a Fault to the other, the FCCs will exchange FCC Log Numbers.
- 2.5.2.3 Both Parties' FCCs will exchange sufficient information to allow for efficient Fault resolution of all affected Services. A standard Fault Management Form will be used by both FCCs to report and receive faults. (Appendix IV)
- 2.5.2.4 Each reported Fault will be investigated by the reporting Party to ensure that the Fault exists and to attempt to establish the location of the Fault.
- 2.5.2.5 Once the Fault is reported, the Parties will decide who will take responsibility for the Fault. The Party who takes responsibility for the Fault shall be called the Fault Owner and the other Party shall be called the Other Affected Party. Where no agreement over ownership can be reached, the Fault Owner will be the Party who was informed of the Fault.
- 2.5.2.6 Internally Detected Faults are Faults that a Party believes to exist within its own network. Once detected, the Party will inform the other Party about any Service Affecting Faults. This also applies to known Service Affecting Faults in a connected Third Party Telecom Provider's network.

2.5.3 Fault Restoration

2.5.3.1 The stages associated with Fault restoration are presented in Figure 5.

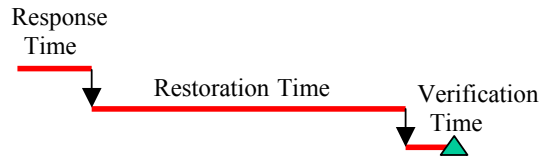

Figure 5

2.5.3.2 If, during Fault restoration, it is established that the ownership of the Fault is in the System of the Other Affected Party, then the roles will be reversed, i.e. the Fault Owner will become the Other Affected Party and vice versa.

2.5.3.3 A Fault is classified as cleared when the Fault Owner informs the Other Affected Party that the Fault has been rectified and the Other Affected Party has verified this.

2.5.3.4 The Response Time (maximum thirty (30) minutes) is the period in which:

- The Parties agree ownership of the Fault i.e. the Fault Owner and Other Affected Party are determined
- The Fault priority is determined; whether fault is Service Affecting or Non Service Affecting. If there is no agreement, then by default the Fault is classified as Service Affecting.
- The Fault Owner specifies expected Restoration Time.

2.5.3.5 The Restoration Time is the period in which:

- Fault Owner clears the Fault
- Fault Owner informs the Other Affected Party of progress and when the Fault is cleared.

2.5.3.6 Fault Restoration Times are specified in the Parameter Schedule.

2.5.3.7 The Verification Time (maximum fifteen (15) minutes) is the period in which the Other Affected Party reports its acceptance or rejection of the Fault clearance to the Fault Owner.

2.5.3.8 Disrupted services may be restored promptly on a temporary basis, to be followed by permanent fault resolution at a later date. This form of restoration shall only be used when the temporary restoration costs are considered by the Fault Owner to be reasonable.

2.5.3.9 The FCCs will manage information relating to all outstanding faults, including status data. This information will be made available to either Party at agreed intervals or as required.

2.5.3.10 Both Parties' field staff may liaise directly to resolve a current fault as deemed necessary. However, all information must be communicated to the respective FCCs to ensure the maintenance of Fault records and the taking of appropriate action.

2.5.4 Re-classifications, suspensions and escalation

2.5.4.1 At any time during the resolution of a Fault, the Other Affected Party may, with sufficient documented justification, request the change in status of the Fault from NSA to SA at which point the Restoration Time will need to be reviewed. Similarly, the Fault Owner may also request a change in status of a fault from SA to NSA with the required documented justification.

2.5.4.2 If for any reason the resolution of a Fault is impeded, due to the Other Affected Party, the Fault Owner may, with proper documented justification, suspend the measurement of the Fault Restoration Time.

2.5.4.3 Fault Escalation can be instigated when:

- a) the Other Affected Party raises concerns about the speed of restoration; or
- b) when the Fault Owner requires greater co-operation from the Other Affected Party; or
- c) when the target Restoration Time for a Fault, as stated in the Parameter Schedule has elapsed without restoration.

2.5.4.4 Initiation of the escalation process shall be done through the Parties' FCCs. The FCCs will be responsible for co-ordinating the entire escalation process and maintaining the escalation records.

2.5.4.5 Initiation of the escalation process is done by phone, fax or other agreed media. Documented records must be kept of the entire process.

2.5.4.6 Every effort shall be made by both Parties to reach agreement at each escalation level before proceeding to the next level.

2.5.4.7 The Parties can agree on set escalation deadlines for specific circumstances.

2.6 PLANNED AND EMERGENCY MAINTENANCE

2.6.1.1 Planned maintenance encompasses:

- work that affects, or has the potential to affect the Carrier System or its underlying E1Network Links or their Quality of Service; or
- work that affects, or has the potential to affect the quality of service provided to Subscriber Connections; or
- work that affects, or has the potential to affect the Quality of Service provided by the other Party's System.

2.6.1.2 The Party planning to carry out planned maintenance activity (the Maintenance Party) should provide at least ten (10) Business Days notice to the other Party. The planned maintenance will be carried out during the maintenance window, which will be determined by the lowest traffic period for the given service.

2.6.1.3 If the other Party determines that the planned maintenance has the potential to adversely affect its Services, then it should contact the Maintenance Party within five (5) Business Days of the first notice, with a view to negotiating a mutually agreed date for planned maintenance activity.

2.6.1.4 Both Parties must be in possession of the final schedule at least three (3) Business Days before the commencement of planned maintenance. If an agreement cannot be reached within this time frame, then the escalation procedure as described in Paragraphs 2.5.4.3 - 2.5.4.7 should be applied, with any necessary modifications.

2.6.1.5 Emergency maintenance is a type of maintenance work that needs to be carried out immediately due to the impact or potential impact to services. If this work affects, or has the potential to affect the other Party's Services, then, as much advance notice will be given as the situation permits.

2.7 MISCELLANEOUS O&M PROVISIONS

2.7.1 Procedure for alteration of numbers

2.7.1.1 Each Party will notify the other in writing of any alterations to the number ranges (or numbers) to which Calls are to be conveyed pursuant to the Service Descriptions. Notwithstanding Clause 33 the date on which such notification is deemed to be received will be the date of receipt.

2.7.1.2 Within three (3) Business Days of date of receipt, each Party will notify all interconnected operators of the alterations to such number ranges.

2.7.1.3 Each Party will perform the necessary alterations to its respective Systems to facilitate the alteration to the number ranges within five (5) Business Days of date of receipt and will inform the other Party of completion of the necessary alterations within one (1) Business Day of completing the necessary alterations.

2.7.1.4 The Parties will co-operate in order to conduct any necessary joint testing, where applicable, and will use all reasonable endeavours to complete such testing within five (5) Business Days of alteration.

2.8 APPENDICES

APPENDIX I	Monthly Performance and issue resolution
APPENDIX II	Forecast
APPENDIX III	Order Plan
APPENDIX IV	Fault Management

Appendix I. Monthly performance and issue resolution

INSTRUCTIONS:

The Service Taker will indicate in Section I, all existing and ordered services. In each month following the report period, both Parties will exchange the information in Sections II and III for each service.

SECTION I – EXISTING & ORDERED SERVICES

Service Taker						
Report date						
Existing network links						
				Trunk Route		
Service no.	Origin	Destination	No. Links	Name	Type IC/OG	No.
Ordered services						
				Trunk Route		
Service no.	Origin	Destination	No. Links	Name	Type IC/OG	No.

SECTION II – MONTHLY REPORT

Service being reported													
Report period													
	Report Month	Previous 12 months											
Report Items		1	2	3	4	5	6	7	8	9	10	11	12
1. Traffic Volumes													
No. of minutes/service (source: billing system)													
No. of calls/service (source: billing system)													
Busy hour (time)													
No. of calls in busy hour													
2. Performance Measures													
Link Availability													
Call Completion Rate													
Total No of Faults													
No. of network faults													
Total network restoration time													
No. of link faults													
Total link restoration time													

SECTION III – DETAILED FAULT INFORMATION

Service Taker						
Service being reported						
Report period						
Fault Details						
Fault log #	Fault reported	Fault class	Other affected party	Cause of fault	Target restoration time	Actual restoration time

Appendix II. Forecast

Service Taker to complete all shaded areas

SECTION I – CONTACT DETAILS

Service Taker				
	Name	Address	Telephone #	Fax #
Liaison Manager				
Planning Manager				
Operations Manager				
Fault Control Manager				
Service Quality Manager				
Project Manager				
<i>This forecast has been submitted as part of the interconnect forecasting procedure and represents our current understanding of the traffic (liaison manager and planning manager unless stated otherwise)</i>				
Signature		Signature		
Name		Name		
Position		Position		
Date		Date		

SECTION II – NETWORK LINKS FORECAST

Service Taker											
Existing point of Interconnection											
Service Taker ISL			Service Supplier ISL								
Service	Service ref.	Carrier System	E1 links forecast								
			Q1	Q2	Q3	Q4	Q5	Q6	Q7	Q8	TOTAL
TOTAL											
New point of Interconnection											
Service Taker ISL			Service Supplier ISL								
Service	Service ref.	Carrier System	E1 links forecast								
			Q1	Q2	Q3	Q4	Q5	Q6	Q7	Q8	TOTAL
TOTAL											

SECTION III – QUARTERLY TRAFFIC FORECASTS

Forecast Quarter						
Start Date			End Date			
Service ref.	Origin	Destination	SERVICE TRAFFIC FORECAST			
			Total traffic (Erlangs)	Busy Hour period	Busy Hour traffic (Erlangs)	No. E1 Links <i>(copy to section II)</i>

Appendix III. Order Plan
SECTION I – CONTACT DETAILS

Service Taker				
	Name	Address	Telephone #	Fax #
Liaison Manager				
Planning Manager				
Operations Manager				
Fault Control Manager				
Service Quality Manager				
Project Manager				
Signature		Signature		
Name		Name		
Position		Position		
Date		Date		

SECTION II – EXISTING SERVICES

Service Taker			Date			
Existing Network Links						
Service ref	Origin/ Destination	Carrier Type	No of Links	Trunk		
				Route name	I/C or O/G	No.

SECTION III - NEW REQUIREMENTS

New requirements							
Interconnect Switches				Carrier system			
Service Taker	Point code	Service Supplier	Point code	Carrier Type	No. Links	Link Usage	Order type New/ Change
Link requirements							
Origin	Destination	Trunk route name	Trunk route type I/C or O/G	No of trunks	Line code Signalling & framing	Ready for test date	Ready for service/ termination date
Change details							
Service	Change Increase Decrease Relocate Reconfigure POC New POC	Trunk route name	Trunk route type I/C or O/G	Time slot info	CIC assignment	Dialled digit info	

SECTION IV – NETWORK OR CIRCUIT DIAGRAM

Separate attachment.

Appendix IV. Fault management form

Both Parties shall maintain a log of the information relating to all reported faults. This information shall be made available to either Party at agreed intervals or as required.

SECTION I - FAULT REPORT

ITEMS	DETAILS
C&W Fault log no.	
Telco Fault Log #	
Fault report date	
Time detected	
Person detected	
Time Reported	
Person Reporting	
Fault owner	
Other Affected Party	

SECTION II - FAULT IMPACT

ITEMS	DETAILS
Fault Type (Network / Carrier System)	
Fault Status (SA/NSA) Critical/Major/Minor Link/Route	
Service Affected	
Supplementary details to aid fault identification	

SECTION III – FAULT RESTORATION

ITEMS	DETAILS
Cause of fault	
Clearance date + time	
Person Clearing	
Person receiving clearance	
Confirmation time	
Person requesting confirmation	
Response time	
Restoration time	
Verification time	

SECTION IV – FAULT RESTORATION ACTIVITIES

DATE	TIME	ACTION TAKEN
Contd ..\		

Fault type	Classification
Critical Link Failure	<i>100% of total signalling capacity is unavailable</i>
Major Link Failure	<i>50% of total signalling capacity is unavailable</i>
Critical Route Failure	<i>50% or more of total capacity of the route is unavailable to carry traffic.</i>
Major Route Failure	<i>25% to < 50% of total capacity of the route is unavailable to carry traffic</i>
Minor Route Failure	<i>1% to < 25% of total capacity of the route is unavailable to carry traffic</i>

SECTION V – FAULT ESCALATION (if appropriate)

Dispute details			
C&W escalation list			
Date	Name	Position	Response
Telco escalation list			
Date	Name	Position	Response

3 Chapter 3 - Billing

3.1 Billing: Introduction

3.1.1.1 This chapter specifies the processes related to billing and accounting applicable to the Services provided between Service Supplier and Service Taker.

3.2 Data Collection and Invoice processing

3.2.1.1 For usage-based services, CDR based billing will be used in electronic or paper format as the Parties may agree.

3.2.1.2 Invoices for the Billing Period will detail each service specified in the Service Schedule together with the Billing Period. Where a service is composed of different rating elements the invoice will also detail which rating elements have been applied and the quantities to which each of the rating elements have been applied.

3.3 Invoice disputes

3.3.1.1 In the event that the Service Taker disputes the accuracy of an invoice pursuant to Clause 9.5, the Parties shall resolve the dispute in accordance with the procedures in Clause 34 and this paragraph 3.3.

3.3.1.2 Service Taker will as soon as practicable, but before the due date of the invoice notify the Liaison Manager of the Service Supplier of the dispute including all necessary details. This notification will be in writing by hand delivery or facsimile message.

3.3.1.3 Where a dispute has arisen, the billing and billed parties will exchange daily summaries for the period under dispute at lowest rating element level to attempt resolution. Failing this, CDRs for the period will be exchanged in the format defined in Paragraph 3.6 of the Joint Working Manual.

3.3.1.4 If the dispute is not resolved within thirty (30) days following referral to the relevant Liaison Managers, either Party may refer the dispute for determination in accordance with the procedures specified in Clause 34. The Parties shall co-operate in such determination and will make all necessary and relevant billing data available. Any sums found to be due or overpaid in respect of the disputed invoice shall be paid within thirty (30) days from the date of determination together with interest at the base lending rate of First Caribbean International Bank from time to time in force plus 2% from and including the day following the due date for payment until the date of payment in full and whether before or after any court judgement or other award.

3.4 Undetected billing errors

3.4.1.1 In the event that a billing error is discovered that occurred in a previous Billing Period as set out in Clause 11.7(b) or 11.7(c), either party may request a review of the invoice for any of those Billing Periods, provided that the request is made within three (3) months of the date of the start of the current Billing Period. In the event of overpayment, the over-payer shall be entitled to a refund of the overpayment. In the event of underpayment, the under-payer shall be obliged to pay the amount due. Any sums found to be due or overpaid in respect of the previously undetected billing error

shall be paid within thirty (30) days from the date of determination together with interest at the base lending rate of the Bank of Nova Scotia from time to time in force plus two per centum (2%) from and including the day following the due date for payment until the date of payment in full and whether before or after any court judgement or other award.

- 3.4.1.2 In the event of billing information being permanently unavailable to either party, the party unable to generate the bill may estimate the amount due based on an estimating method agreed by both parties in advance. The party performing the estimation will supply the detailed data and calculation on which the estimate is based.

3.5 Late usage

- 3.5.1.1 Where CDRs are only temporarily unavailable, they should be included in the subsequent Billing Period as late usage. This late usage should appear on the invoice separately from usage that occurred during the Billing Period which the invoice covers. At the latest, any late usage should be billed within 3 months of its occurrence.

3.6 Validation

- 3.6.1.1 In cases where dispute resolution requires that CDRs be exchanged, the following format will be used. Alternative formats may be used when agreed by both Parties. A process will be defined by the Parties' Liaison Managers, to identify and act upon relevant discrepancies between Billing Data.

Field	Field Size	Format	Meaning
<i>a-number</i>	20	<i>Alphanumeric</i>	<i>The dialling number</i>
<i>b-number</i>	28	<i>Alphanumeric</i>	<i>The dialled number</i>
<i>Point of Connection</i>	15	<i>Alphanumeric</i>	<i>The C&W interconnect office</i>
<i>Incoming route</i>	7	<i>Alphanumeric</i>	<i>Populated for Calls sent to C&W</i>
<i>Outgoing Route</i>	7	<i>Alphanumeric</i>	<i>Populated for Calls sent by C&W</i>
<i>Start date/time</i>	12	<i>Numeric</i>	<i>Call start time format YYYYMMDDHHMM</i>
<i>Duration</i>	6	<i>Numeric</i>	<i>Call duration format HHMMSS</i>

3.7 Retention of Billing Data

- 3.7.1.1 Each Party will keep Billing Data in an appropriate form for at least one (1) year.

4 Chapter 4 – Testing

4.1 Interconnect Testing - Objectives & Scope

4.1.1 Objectives

4.1.1.1 This chapter details the approach for testing the interconnection between C&W and the Telco.

4.1.1.2 The objectives of the testing are:

- to maintain the integrity of both networks
- to meet the contractual specifications
- to locate and enable resolution of faults with the interconnection
- to ensure that billing is completed correctly.

4.1.2 Scope

4.1.2.1 The chapter describes:

- process to support the testing
- project plan to support the testing
- roles and responsibilities
- phases of testing with entry and exit criteria
- detailed test cases
- results sheets
- how to manage a test failure

4.2 Interconnect Testing Framework

4.2.1.1 The following framework is to be used to support interconnect testing.

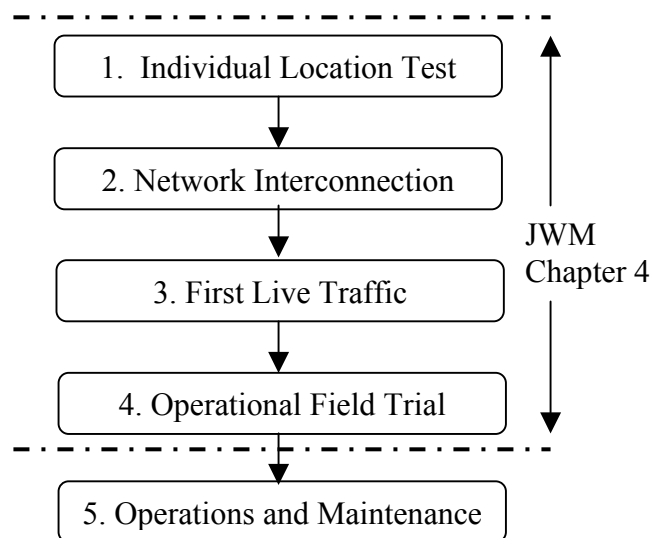

Fig. 1 - Process flow for Interconnect Testing.

Individual Location Test	This phase of the testing verifies that the network of C&W and the Telco are suitable for interconnection. Each Party must demonstrate that its interface conforms to the technical chapter (chapter 1) of the Joint Working Manual.
Network Interconnection Test	The Network Interconnection Test ensures the interoperability of the Systems, management of the Network Links, tests whether all types of Calls can be made and includes CCSS7 tests and exchange of CDR records.
First Live Traffic	This is the first trial of the interconnection in a test field environment with limited non-billable traffic. This phase considers maintenance and fault handling procedures, and verifies that the correct bills are delivered. It also tests that the roles and responsibilities are clear.
Operational Field Trial	This is the phase prior to the general operation of the interconnection. During this phase, fine-tuning of operational procedures takes place. All functions must be verified including start-up/shut-down procedures, disaster recovery, security, and performance under severe load. This phase uses non-billable and billable traffic depending on the test.

Table 1 - overview of proposed interconnect testing

4.3 Test Specification Structure

4.3.1.1 Each of the test phases will follow the same structure to derive and document the tests.

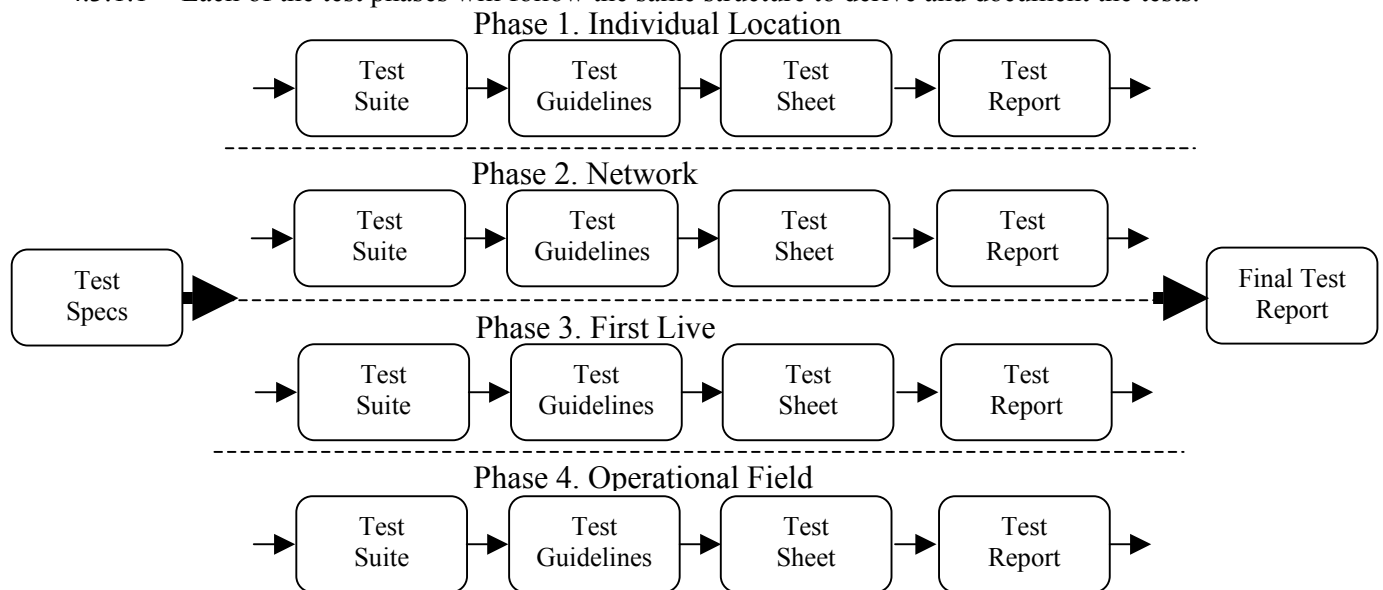

Fig. 2 - Structure of each test phase

Test Specification

4.3.1.2 The Test Specification contains the total set of Test Suites and Test Guidelines agreed between both parties to support the testing.

Test Suite

4.3.1.3 The Test Suite is a set of defined Test Guidelines that relate to a particular functionality e.g., billing, and inter-operability. A Test Suite can be tested in whole or in part against any of the four test phases.

Test Guidelines

4.3.1.4 The Test Guidelines contain:

- list of all the test cases to be completed
- justification for test cases
- detailed test case procedures
- test case pass/fail criteria
- details of other test data to be recorded
- planning to co-ordinate and track the testing progress.

Test Sheet

4.3.1.5 The Test Sheet contains an accurate record of the test completed and the outcome of the test.

Test Report

4.3.1.6 The Test Report is a summary of the tests executed. It also provides details on faults, re-tests and exceptions. The Test Report is signed by both parties and is proof that the testing was completed. It is the main input to deciding whether the current phase of work can be exited.

4.3.1.7 The Final Test Report is compiled at the end of all the testing and highlights any outstanding faults, issues and concerns. It is the main input into deciding whether the Joining Service is ready to become fully operational.

4.4 Test Phases

4.4.1 Individual Location Test Process

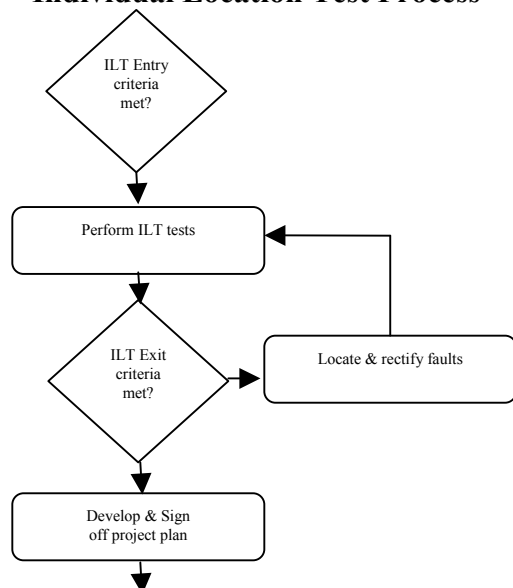

4.4.1.1 The goal of the Individual Location Test is to determine whether the infrastructure of each Party exhibits sufficient functionality to interconnect. The tests consider the following areas:

- Conformance to relevant communication standards and technical specifications as described in the technical chapter
- Implementation of the charging mechanisms
- Charging calibration.

4.4.1.2 Each Party performs its own Individual Location Test. If either Party fails the testing the interconnection cannot proceed until the fault(s) have been corrected. Each Party is responsible for correcting any faults, and carrying out any modifications or additions to its own interconnect equipment to rectify the situation.

Entry Criteria	Signed Order Plan / agreement on the connection; Test Guidelines completed for this phase; Each Party has sufficient resource available to complete this phase of testing; Provisional project plan drafted.
Exit Criteria	Each Party has completed Individual Location Test and passed all tests; List of known deviations and imperfections available; No known fatal, inadmissible or major faults; Test results made available to each party; Test Report is approved and signed by both parties.

4.4.2 Network Interconnection Test Process

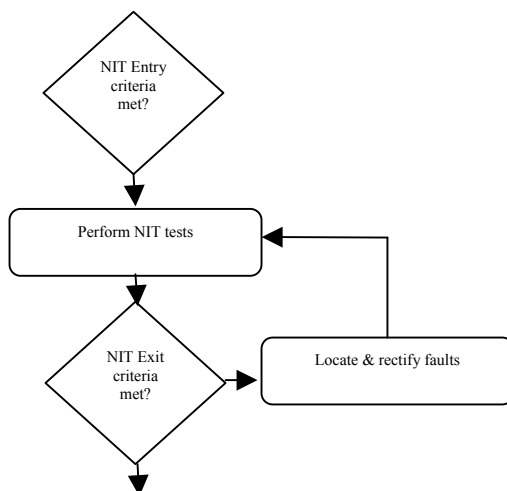

4.4.2.1 This phase of testing minimises operational risk for both Parties. The Network Interconnection Test tests consider the following areas:

- Interoperability of the signalling traffic
- Checking whether charging mechanisms of both Parties are in line.

Entry Criteria	Project Plan, documented and signed by both parties; List of known deviations and imperfections available; Test Guidelines have been completed for this phase; Both Parties have sufficient resource available to complete this phase of testing; The interconnection between C&W's ISL and the Telco ISL is ready for this phase of testing.
Exit Criteria	Successful completion of the Network Interconnection Tests; No known fatal, inadmissible or major faults; Planned solution for all faults has been documented; Test results made available to each party; Test Report is approved and signed by both parties.

4.4.3 First Live Traffic Process

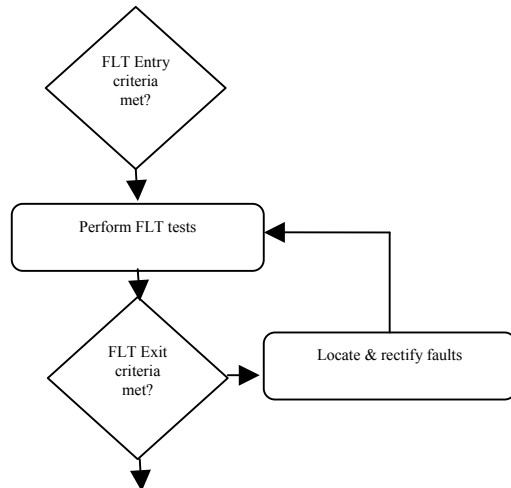

4.4.3.1 The First Live Traffic test determines whether the networks of both Parties are correctly interconnected. In addition to testing the basic interconnection, billing and supporting processes are tested during the First Live Traffic tests.

4.4.3.2 No billable traffic should be used during this phase of the testing.

4.4.3.3 The First Live Traffic tests consider the following areas:

- Interoperability of signalling traffic
- Service tests (can all types of calls be established)
- Routing tests (is the Telco reachable from all locations)
- Whether charging mechanisms of both Parties are in line

- Bill test (on basis of CDRs from test traffic)
- Process test (e.g. maintenance and error procedure).

Entry Criteria	List of known deviations and imperfections available; Both Parties have sufficient resource available to complete this phase of testing; The interconnection between C&W's ISL and the Telco ISL is fully installed and operational; List of known deviations and imperfections available; Test Guidelines have been completed for this phase; O&M procedures are available.
Exit Criteria	Successful completion of the First Live Traffic Tests; No fatal, inadmissible or major faults are present; Planned solution for all faults has been documented; Test results made available to each Party; Test Report is approved and signed by both Parties .

4.4.4 Operational Field Trial Process

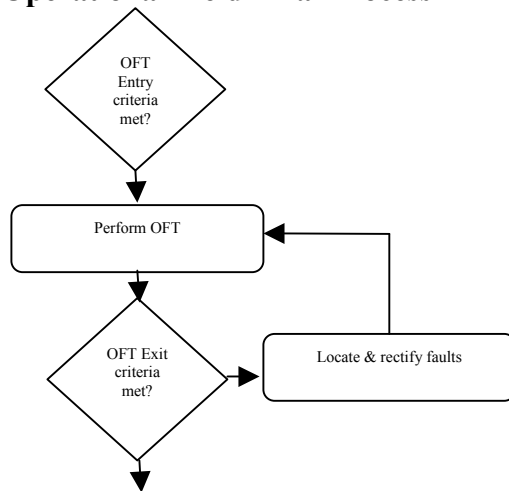

4.4.4.1 The Operational Field Trial is the phase prior to general availability of the interconnection. During the Operational Field Trial all outstanding faults from previous test phases have to be resolved. During this phase billable traffic is passed for the first time. The objective of this Trial is to ensure that the operational and maintenance procedures are effective to deal with any issues that will arise.

Entry Criteria	No changes in the interconnection since conclusion of the previous phase of testing; List of known deviations and imperfections available; Test Guidelines completed for this phase; Both Parties have sufficient resource available to complete this phase of testing.
Exit Criteria	No faults are present; Support for further Field introduction is available;

	Performance and stability statistics are within the limits defined in the contractual agreement; Applicable O&M procedures approved; Test results made available to each Party; Operational Field Trial Test Report is approved and signed by both Parties; Final Test Report is approved and signed by both Parties.
--	---

4.5 Test Sheets & Report

- 4.5.1.1 The Test Sheets contain the results of executed tests for each test phase. These results can be positive (passed), or negative (failed), and where applicable additional information may need to be recorded.
- 4.5.1.2 For each phase of testing a test report must be completed. In all cases the Test Report should be completed and signed by both Parties. The Test Report should at a minimum reflect what tests have been performed, whether the result was as expected or if deviations were observed.

4.6 Test Suites

- 4.6.1.1 The interconnect Test Suites required are shown below. Within each suite there are key areas of testing, which are shown below. Agreement to this needs to be confirmed through the Project Plan and then further detailed in the Test Guidelines.

	Test Suites	Tests Phases			
		ILT	NIT	FLT	OP
1	Conformance tests: 1. Protocol conformance 2. Electrical conformance 3. EMC conformance 4. Local Operation Tests	X X X X			
2	Interoperability tests: 1. End to end transmission 2. Network Synchronisation 3. C7 signalling 4. Network routing 5. Network management		X X X X X	X X X X X	X X X X X
3	Stability and Security tests: 1. Load tests 2. Stress tests (fault situations) 3. Fraud	X	X X X	X X	
4	Service tests: 1. Services from C&W to Telco 2. Services from Telco to C&W 3. Changed services 4. New services			X X X	X X X
5	Billing: 1. Charging calibration 2. Charging per service (CDRs) 3. Billing aggregates 4. Billing service	X	X X	X X X X	X X X X
6	Processes: 1. Service & Element management 2. Operation processes 3. Maintenance processes 4. Customer processes			X X X X	X X X X

4.6.1.2 The Test Suites are described in overview below.

Conformance Testing

4.6.1.3 The test suite confirms that the protocol supported meets the technical specification. Conformance testing deals with the behaviour of the protocol, and not with processing capacity under critical load conditions. It may also address invalid behaviour testing.

Interoperability Testing

4.6.1.4 An Interoperability test involves at least two networks which are interconnected. In these tests it is verified whether elements of a procedure (including parameters) across the common boundary, are in compliance with the specification. The test sequences across the point of observation are not generated or inserted at the point of observation itself, but at interfaces contained within the systems under test.

Stability and Security Test

4.6.1.5 Stability tests consist of load and stress tests. Load tests are tests of the interconnection in situations of relatively heavy use. Stress tests are tests in which fault situations are introduced in the interconnection. The point of observation is the common boundary between the interconnected systems. In both tests it should be verified that the interconnection works under extreme circumstances. Network fraud testing is included in this test suite.

Service Test

4.6.1.6 These tests ensure the services supplied by either Party will operate in a manner that is compliant with the Service Descriptions and technical characteristics.

Billing

4.6.1.7 Billing verifies that the charging mechanism (based on CDR generation) supported by both parties is accurate and meets the agreed specification.

Processes

4.6.1.8 Process tests involve the testing of operation, maintenance and customer processes. They also include documentation, training of personnel and support of the interconnection. In some of these areas an actual test case cannot be written to test a process and the relevant people, as part of the exit criteria, will review the process.

4.7 Fault handling procedure to be used in testing phases

4.7.1.1 If a Fault is identified in a testing phase it should be registered and the test manager for the phase informed. The Fault will then be classified, passed on to the installation / development team and resolved. When the Fault is resolved the new implementation may need to be tested again and the result recorded. When the retest is successful, the Fault can be closed on the Fault list that the test manager controls.

4.7.1.2 The test teams of either party can detect faults. The test manager for the corresponding test phase will issue a fault report in the format set out in Appendix II and register it on the fault list in the format set out in Appendix III. The fault report shall include fault classification. The classification is defined by mutual agreement between the test managers. If there is a conflict about the classification, the Overall Test Managers will be consulted.

4.7.1.3 The fault report and fault list will use the same numbering convention so that a fault number will relate to only one specific fault throughout the end to end fault resolution process. The numbering convention consists of x.y. Where x indicates the phase number when the fault was identified, and y is a number allocated to identify the fault, starting at one.

Phase Name	Phase Number (i.e. x.y)
Individual Location Tests	1.y
Network Interconnection Tests	2.y
First Live Traffic	3.y
Operational Field Trial	4.y

4.7.1.4 The operations and development team is responsible for resolving the fault. Once the fault is resolved the team updates the fault report with details of the solution. If the fault is solved before the end of the related test phase, the test manager organises a retest, otherwise the Overall Test Manager should arrange a retest. When the retest is successful the fault report can be closed. If the retest is not successful, the fault is sent back to the operations and development team. Again re-testing is necessary until the fault is resolved.

4.7.1.5 Where faults have created extreme delays due to repeated fault location, resolution and re-testing, the Overall Test Managers will decide whether to progress with the fault resolution. This will avoid a loop in the fault handling procedure.

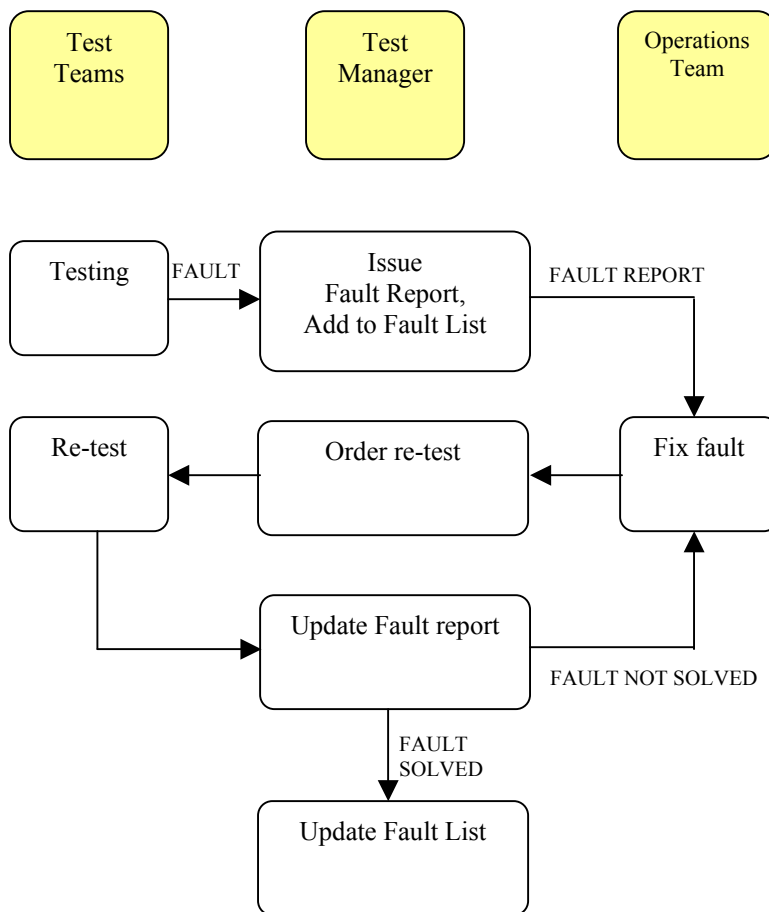

4.8 Fault Classification

4.8.1.1 There are five categories to which a fault can be allocated during testing. A fault must always be allocated to one of these categories and for each fault it should be determined which operator will take responsibility for resolving it. Corrections of the faults should be made within the time agreed for each fault category.

Fault Category	Repair Time
Fatal	Immediately
Inadmissible	3 days
Major	4 weeks
Minor	before Operational Phase
Imperfections	before general availability

Fatal faults

4.8.1.2 A fault is classified ‘fatal’ if this fault causes a situation in which it is not possible or useful to continue testing. Fatal faults have a significant impact on the test schedule, as all test activities will be stopped until the fault is rectified. Fatal faults therefore need to be fixed immediately.

Inadmissible faults

4.8.1.3 Inadmissible faults are faults which are not allowed in the operational phase but can be allowed in a test phase. Although a test phase can be continued if such a fault occurs, the solution for the fault has to be available within 3 days unless otherwise agreed.

Major faults

4.8.1.4 Major faults affect the quality of the service in operational status. After a major fault has been detected, the solution for the problem has to be available within four weeks unless otherwise agreed.

Minor faults

4.8.1.5 Minor faults also affect the quality of a service in an operational situation. However these faults are not perceived by an end-user and are less urgent to resolve. Both parties need to determine the period of time in which the solution for these faults need to be made available/ deployed and must be completed by at least the start of the operational phase.

Imperfections

4.8.1.6 Imperfections are all faults that do not affect the Quality of Service. The faults must be solved before general availability. Depending on the possibility, the solution may be covered in future upgrades.

4.8.1.7 Where there are issues concerning fault classification and/or the cause of the fault, the Overall Test Managers should be consulted.

4.8.1.8 Faults have to be documented in the corresponding test reports and handled as described in the previous section.

4.9 Additional roles and responsibilities for testing

4.9.1.1 The acceptance of the interconnection is the responsibility of both parties who must verify the quality of the testing process and the test results. The following sections describe the roles and responsibilities that need to be filled in order to keep the test process clear and manageable. The project plan will contain details of test organisations.

Overall Test Manager

4.9.1.2 At each stage of testing there needs to be regular contact between the operators to track the progress of testing and resolve any issues that could arise. Each operator will appoint a person who is in charge of testing and known as the Overall Test Manager. The Overall Test Manager should overview all test activities, planning and constantly monitors interconnect testing progress.

4.9.1.3 The Overall Test manager has the following responsibilities:

- completion of the project plan
- tracks progress of each test phase
- checks entry and exit criteria for each phase
- overall ownership of the Fault List for the operator
- confirms completion of all test phases
- delivery of the final test report
- delivery of interconnection to the O&M phase.

Test Manager

4.9.1.4 For each phase a test manager will be assigned with the following responsibilities:

- detailed planning of the test phase (documented in the Test Guidelines);
- execution of the tests for the corresponding test phase;
- reporting testing progress to the Overall Test Manager;
- issuing Fault Reports;
- maintaining the Fault Report list (with the Overall Test Manager);
- completing the Test Report.

4.10 Interconnect Testing Documentation

4.10.1.1 The interconnect testing documentation is as follows

	Document	Responsible persons
Overall	Project Plan	Overall Test Manager
	Fault List	Overall Test Manager
	Final Test Report	Overall Test Manager
Individual Location Test	ILT Test Plan	ILT Test Manager
	ILT Test Guidelines	ILT Test Manager(s)/ ILT Testers
	Fault Reports	ILT Test Manager(s)
	ILT Test Report	ILT Test Manager(s)
Network Interconnection Test	NIT Test Plan	NIT Test Manager(s)
	NIT Test Guidelines	NIT Test Manager(s)/ NIT Testers
	Fault Reports	NIT Test Manager(s)
	NIT Test Report	NIT Test Manager(s)
First Live Traffic	FLT Test Plan	FLT Test Manager(s)
	FLT Test Guidelines	FLT Test Manager(s)/ FLT Testers
	Fault Reports	FLT Test Manager(s)
	FLT Test Report	FLT Test Manager(s)
Operational field trial	OFT Test Plan	OFT Test Manager(s)
	OFT Test Guidelines	OFT Test Manager / OFT Testers
	Fault Reports	OFT Test Manager(s)
	OFT Test Report	OFT Test Manager(s)

Appendix I. Summary of Interconnect Tests

<p>SECTION I – PHYSICAL INSPECTION Ensure Optical Distribution Frame termination points meet agreed standard. Ensure networks of both Parties are prepared to agreed std Ensure both Parties have interfaces that conform to agreed standards Test electrical wiring & grounding</p>	<p>SECTION IV – TEST CALLS Origination Routing Destination Transmission Quality Billing Verification/ Validation Billing Record Processing</p>
<p>SECTION II – LINK TESTS Link Code Signalling Compatibility Framing Compatibility Bit Error Test (BET): 0 over 24 hrs. Frame Loss: 0 over 24 hrs. DSX-1 Standards Volt Standard</p>	<p>SECTION V – SYSTEM FAILURE & ALARM TESTS Verify all relevant alarm points are wired. Generate system alarm and validate expected notification. Test system failure and recovery alarms. Conduct system back-up & recovery procedures. Perform system security tests.</p>
<p>SECTION III – C.7 SIGNALLING TESTS Link State Control Transmission & Reception Control Signalling Link Management Changeover Change back Forced Rerouting (where necessary) Controlled Rerouting (where necessary) Signalling Route Management Circuit Supervision Normal Call Set-up Ordinary Calls</p>	<p>SECTION VI – OPERATIONAL FIELD TRIAL Operate system for agreed period. Verify system performance under load conditions. Monitor service quality during high traffic. Modify and re-test as required.</p>

Appendix II. Fault Report Template for testing

Fault Report between C&W and Telco

Part I (to be completed by one of the test-teams)

Test Case Number:		
Description of test case:		
Expected result:		
Observed result:		
Comments (concerning the configuration, related problems, consequences, hints)		
Name:	Date:	Signature:

Part II (to be completed by test managers)

Required action(s)	Who	Deadline	Fault classification <small>(Note 1)</small>
Test Manager	Date:	Signature:	
Telco			
Test Manager	Date:	Signature:	
C&W			

Note 1:-

* = imperfection, ** = minor, *** = major, **** = inadmissible, ***** = fatal

Part III (to be completed by operations & development team)

Action taken to resolve fault:	
Remaining open issues:	Re-test necessary (Y/N)
Name:	Signature:
Date:	

Part IV (to be completed by the test team)

Result of the re-test:
Comment:

Name:	Date:	Signature:

Appendix III. Fault List

Problem List between C&W and Telco

Reference Number	Date Logged	Owner	Priority	Status	Date Expired	Description	Action By